

Samostojeći kabelski razdjelni ormari KVS

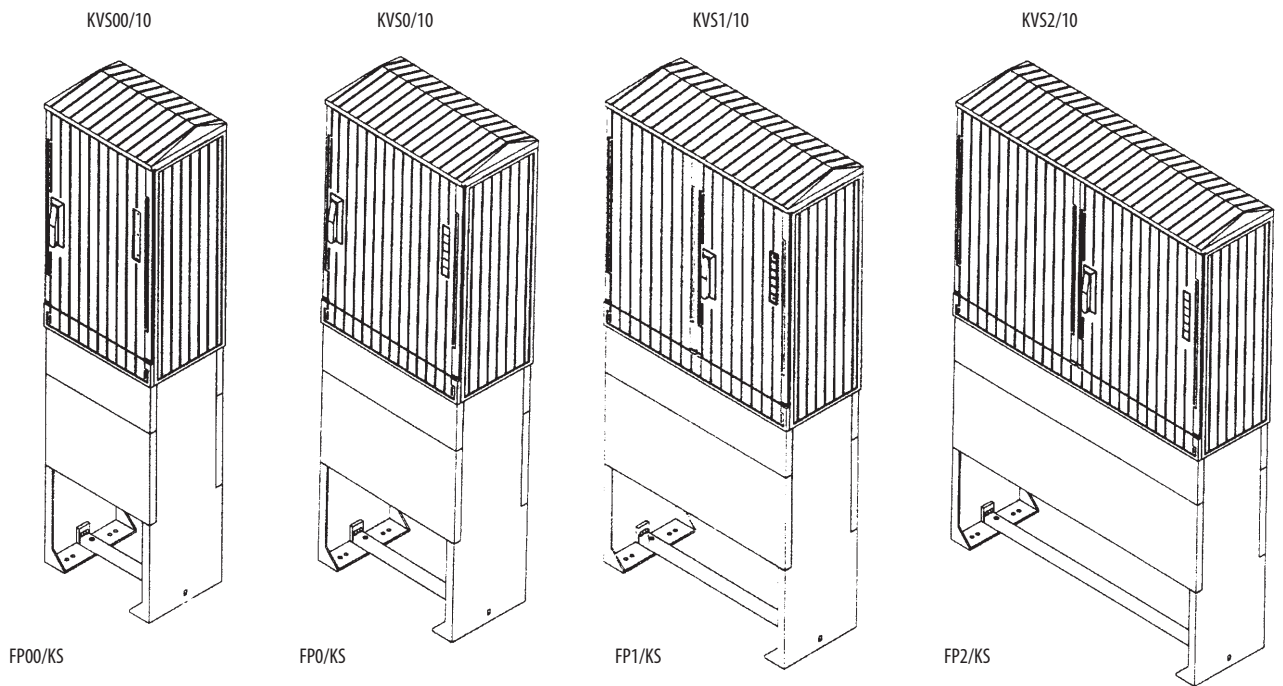

U ormare mogu se ugraditi letve s rastalnim ulošcima. U pojedine tipe ormara moguće je ugraditi sljedeći broj letava veličina 1,2,3:

- KVS00/10 4 letve sa osiguračima
- KVS0/10 5 letva sa osiguračima
- KVS1/10 7 letva sa osiguračima
- KVS2/10 10 letva sa osiguračima

Ugraditi je moguće i letve sa osiguračima veličine 00.

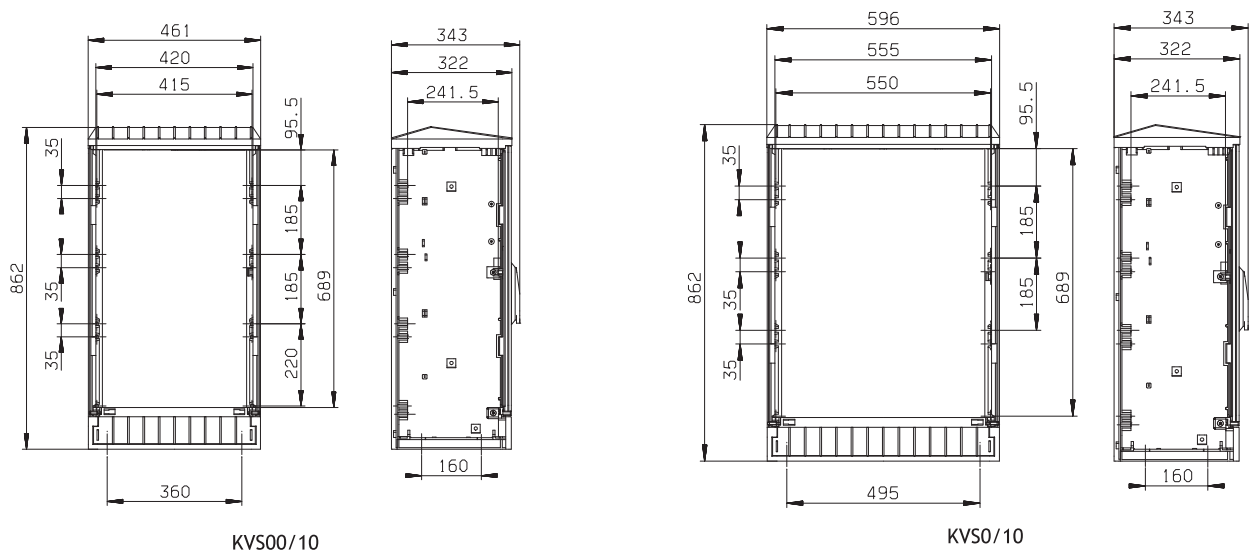

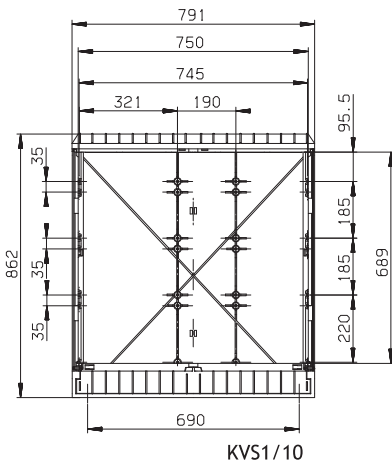

KVS1/10

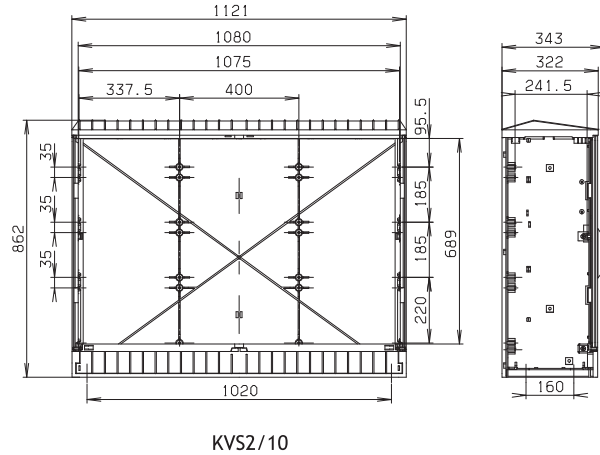

KVS2/10

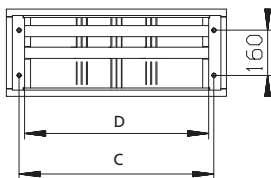
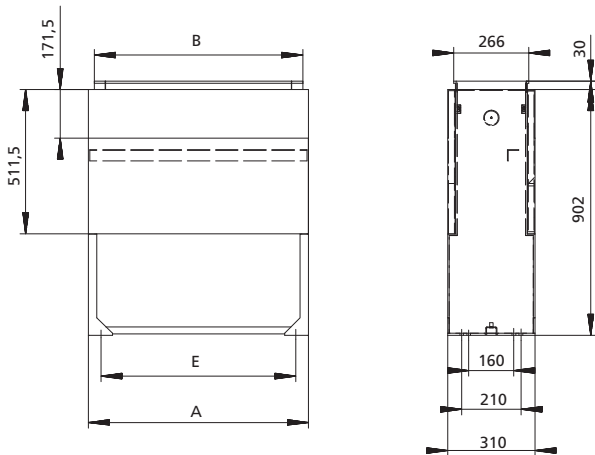

Dimenzije za poliesterske postolje

tip	A	B	C	D	E
FP00/KS za KVS 00/10	450	408	360	322	360
FP0/KS za KVS 0/10	585	543	495	457	495
FP1/KS za KVS 1/10	780	738	690	652	690
FP2/KS za KVS 2/10	1110	1068	1020	982	1020

Pravilna montaža KVS razdjelnog ormara

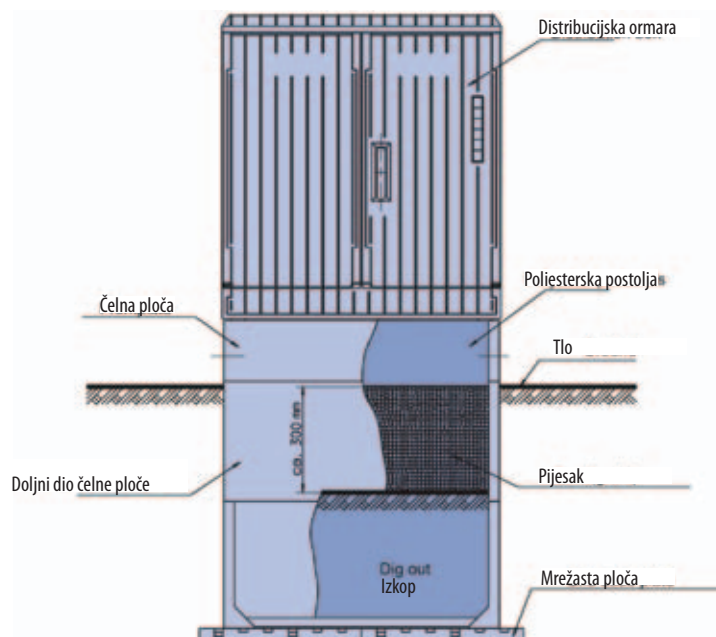

Kondenzacija u razdjelni ormarima

Obziran na atmosferske uslove, buđenžirana voda se stvara u kablovima i razdjelnima ormarima na unutarnji površini. Vlaga muže dovesti do korozije metalnih dijelova i formacije površinskih struja.

Tehnički podaci

